

INTERNAL REPORT NO. 31  
AUGUST, 1981

A THEORETICAL INVESTIGATION OF  
VENTING AND ACOUSTIC LEAKAGE

BY

JOHN MACRAE

AUDIOLOGY RESEARCH SECTION

LIBRARY COPY

LIBRARY  
NATIONAL ACOUSTIC LABORATORIES  
ULTRASONICS INSTITUTE  
155 OSWALD STREET  
BRATHELDON NSW



NAL

NATIONAL  
ACOUSTIC  
LABORATORIES

COMMONWEALTH  
DEPARTMENT  
OF HEALTH

al 621.395.92 MAC

NATIONAL ACOUSTIC LABORATORIES  
COMMONWEALTH DEPARTMENT OF HEALTH

NATIONAL ACOUSTIC  
LABS. C.O. LIBRARY  
ALRN 0-4215  
AN NA - copy A  
DATE 8-11-81

INTERNAL REPORT NO. 31

AUGUST, 1981

A THEORETICAL INVESTIGATION OF VENTING AND ACOUSTIC LEAKAGE

BY

JOHN MACRAE

AUDIOLOGY RESEARCH SECTION

MILLERS POINT, SYDNEY, AUSTRALIA

Theoretical calculations were carried out to study (1) the effects of earmould venting, acoustic leakage around earmoulds and the combination of venting and acoustic leakage on SPL in a modified Zwislocki coupler (representing the average ear) and (2) the transmission of sound into a modified Zwislocki coupler through venting, acoustic leakage and the combination of venting and acoustic leakage.

Constant inner diameter venting was modelled as a tube with a length of 2 cm and with an inner diameter of 1, 2 or 3 mm. Acoustic leakage was modelled as a tube 2 cm long with an inner diameter of 1.2, 1.5 or 1.8 mm and with added acoustic resistance of 2000, 600 or 400 acoustic ohms, respectively.

The acoustic leakage was modelled on the basis of information provided by Angaard Johansen (1975) and Lybarger (1979) and on the results of probe tube microphone measurements of the transmission loss of in situ loose and tight hard acrylic full shell earmoulds given in Table 3. Estimates of the transmission loss of normal hard acrylic earmoulds, obtained from the data provided by Frank (1980), are also given in Table 3.

The network analogs used in the calculations are given in Fig.1 and the values of the analog elements are given in Tables 1 and 2. The results of the calculations are given in Figs.2 to 19. As would be expected, acoustic leakage has its greatest effect on the 1 mm inner diameter vent and in the region of the vent-coupler resonance and, the larger the acoustic leak, the greater its effect on the venting.

#### REFERENCES

Angaard Johansen, P., An evaluation of the acoustic feedback damping for behind the ear hearing aids. Research Laboratory for Technical Audiology, Odense, Denmark, Report 75.1, 1975.

Frank, T., Attenuation characteristics of hearing aid earmoulds. *Ear and Hearing*, 1:161-166, 1980.

Lybarger, S.F., Controlling hearing aid performance by earmold design, in *Auditory and Hearing Prosthetics Research*, ed. V.D. Larson et al., Grune and Stratton, New York, 1979.

TABLE 1  
VALUES OF ANALOG ELEMENTS

ELEMENT	VALUE	UNITS
R1	1000	OHMS
R2	var.	"
R3	10	"
R5	80	"
R6	1200	"
R7	650	"
R8	970	"
R9	340	"
L0	var.	MILLIHENRIES
L1	"	"
L2	"	"
L3	"	"
L4	1.7	"
L5	1.7	"
L6	580	"
L7	109	"
L8	70	"
L9	5.2	"
C1	.434	MICROFARADS
C6	.07	"
C7	.12	"
C8	.12	"
C9	.15	"

TABLE 2

## VALUES OF ANALOG ELEMENTS

## (A) VALUES OF VENT ELEMENTS

I.D. (mm)	L1 (mH)	L3 (mH)
1	306	6
2	76	3
3	34	2

## (B) VALUES OF ACOUSTIC LEAK ELEMENTS

LEAK (type)	I.D. (mm)	R2 (ohms)	L0 (mH)	L2 (mH)
LOOSE	1.8	400	90	3
NORMAL	1.5	600	136	4
TIGHT	1.2	2000	220	6

TABLE 3  
TRANSMISSION LOSS OF EARMOULDS (DB)  
FREQUENCY (KHZ)

TYPE	.25	0.5	1.0	2.0	3.0
LOOSE	0	-3	-8	-17	-24
NORMAL	-2	-7	-14	-22	-27
TIGHT	-13	-15	-19	-28	-32

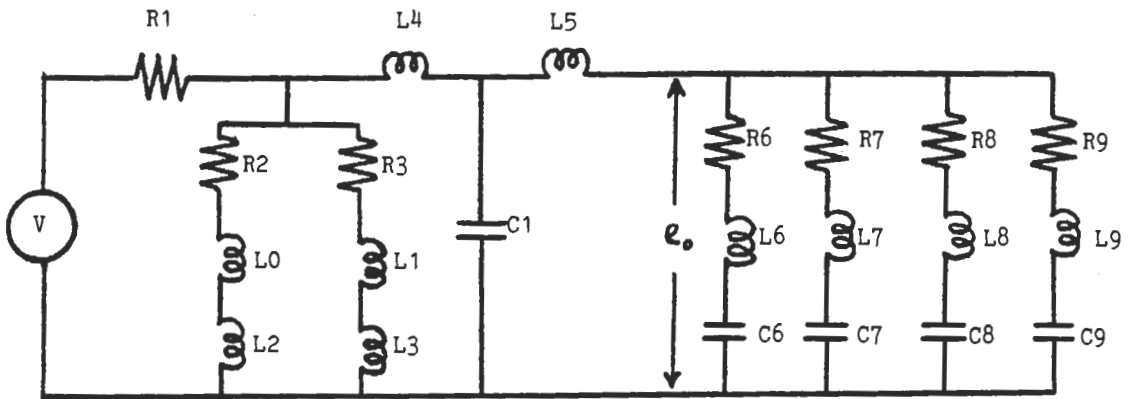

(A)

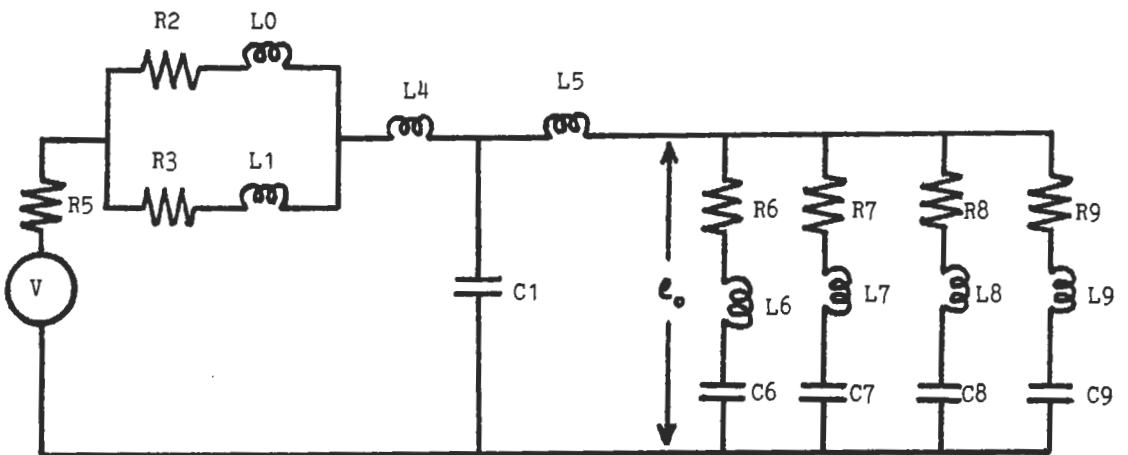





(B)

Fig.1: (A) Network analog of the transmission of sound to a modified Zwislocki coupler with an acoustic leak and a vent.

(B) Network analog of the transmission of sound to a modified Zwislocki coupler through an acoustic leak and a vent.

KEY TO FIGURES

	NO VENT OR LEAK
	LEAK ONLY
	VENT ONLY
	VENT + LEAK



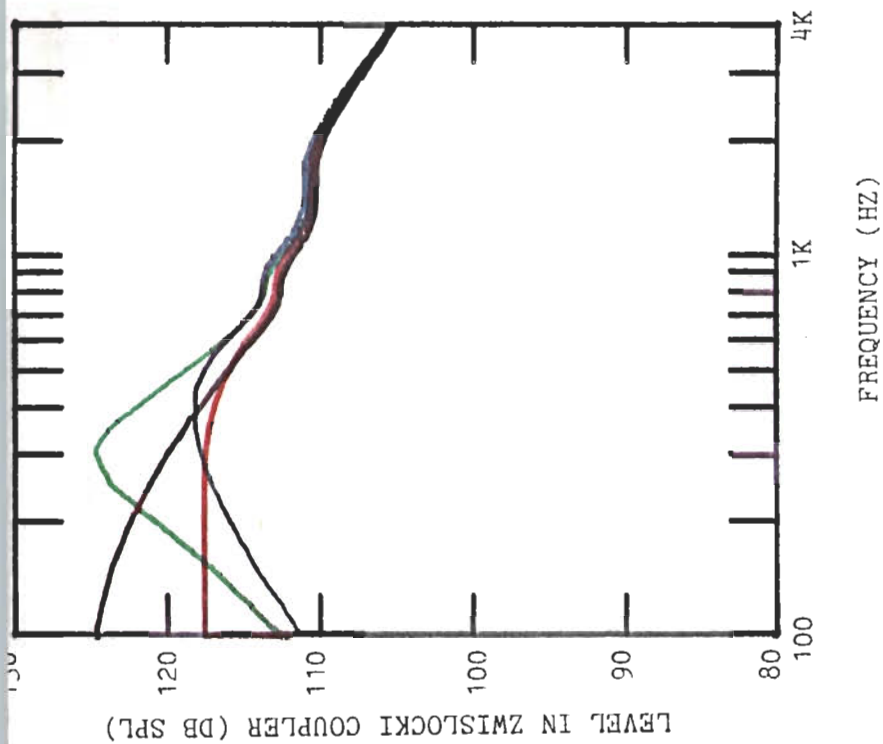

Fig.2: Calculated effects of 1 mm  $\emptyset$  vent, normal acoustic leak and 1 mm  $\emptyset$  vent plus normal acoustic leak on Zwislocki coupler response.

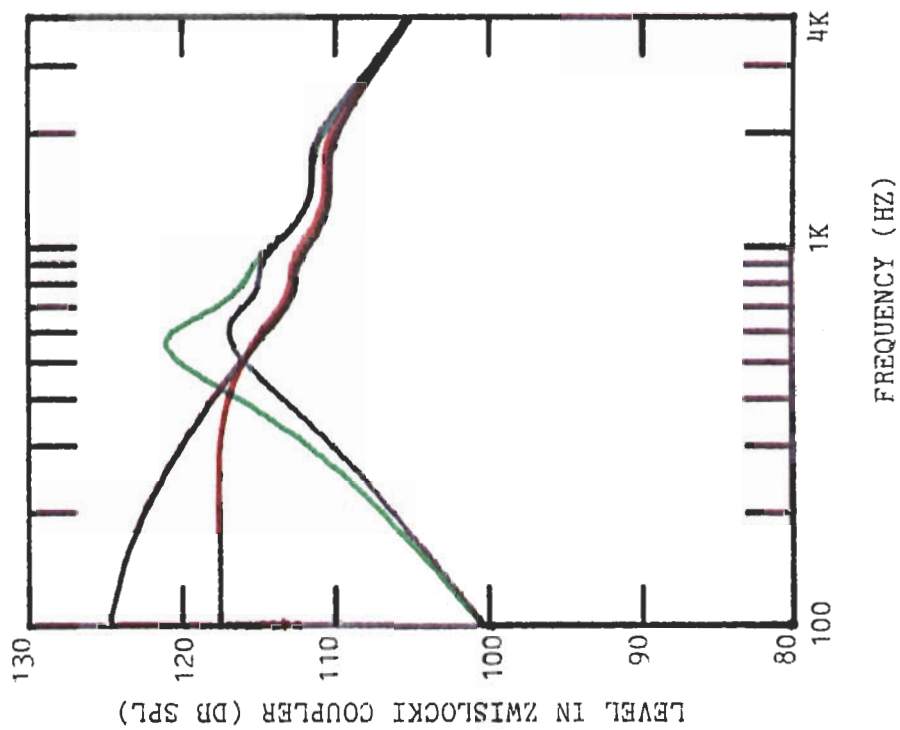

Fig.3: Calculated effects of 2 mm  $\emptyset$  vent, normal acoustic leak and 2 mm  $\emptyset$  vent plus normal acoustic leak on Zwislöcki coupler response.

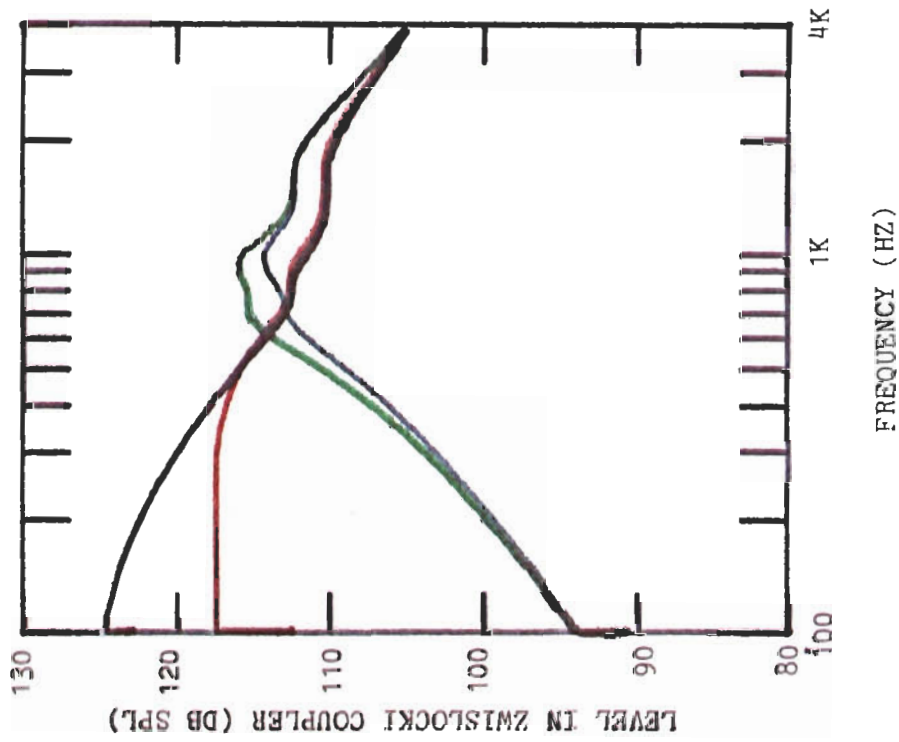

Fig.4: Calculated effects of 3 mm  $\emptyset$  vent, normal acoustic leak and 3 mm  $\emptyset$  vent plus normal acoustic leak on Zwislowski coupler response.

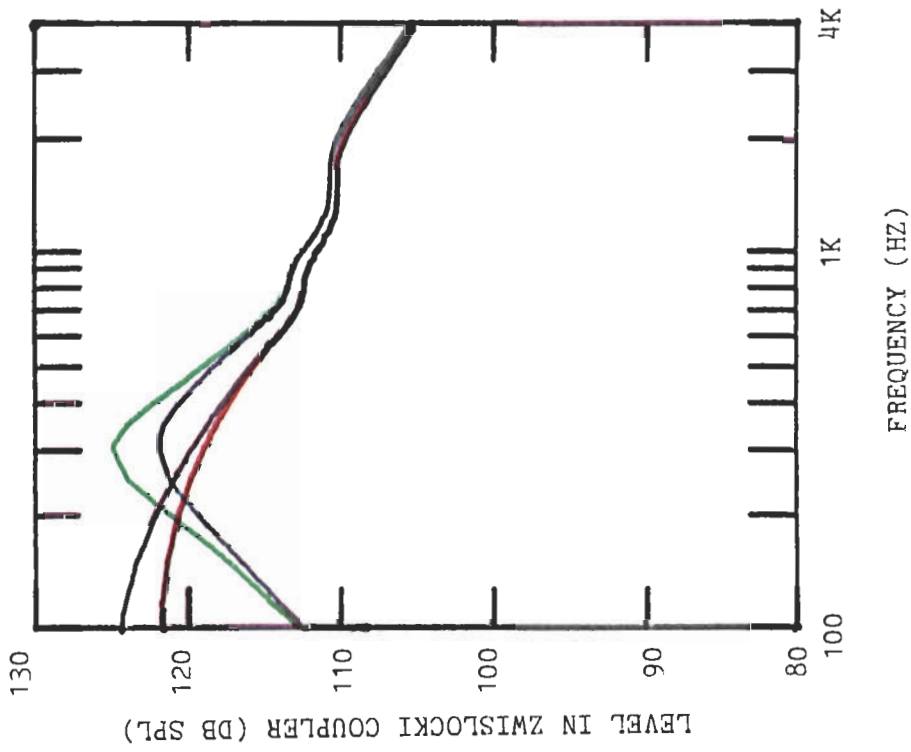

Fig. 5: Calculated effects of 1 mm  $\emptyset$  vent, tight acoustic leak and 1 mm  $\emptyset$  vent plus tight acoustic leak on Zwislowski coupler response.

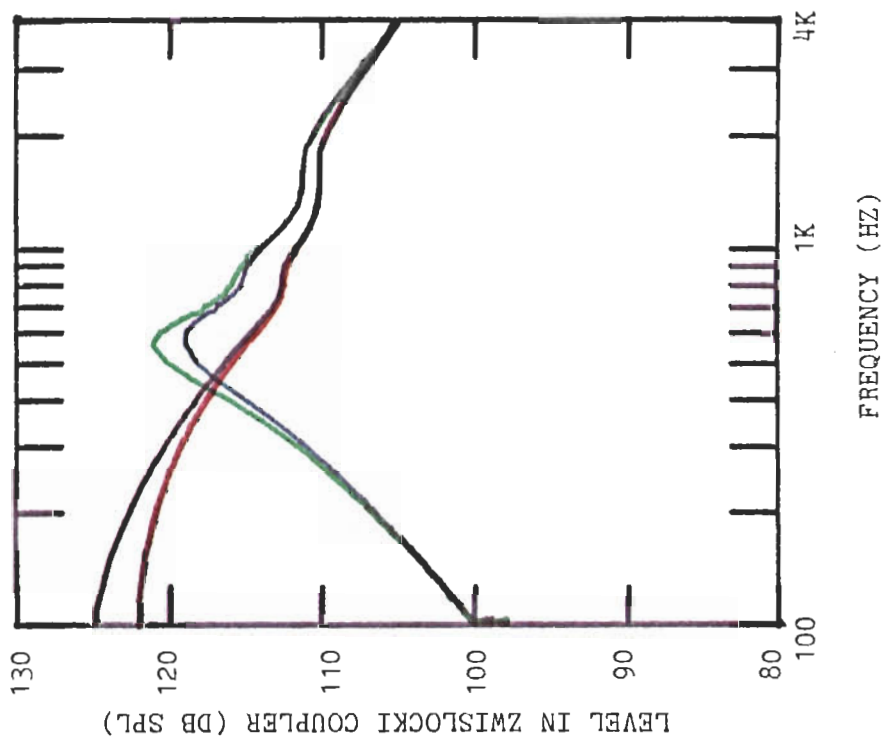

Fig. 6: Calculated effects of 2 mm  $\emptyset$  vent, tight acoustic leak and 2 mm  $\emptyset$  vent plus tight acoustic leak on Zwislowski coupler response.

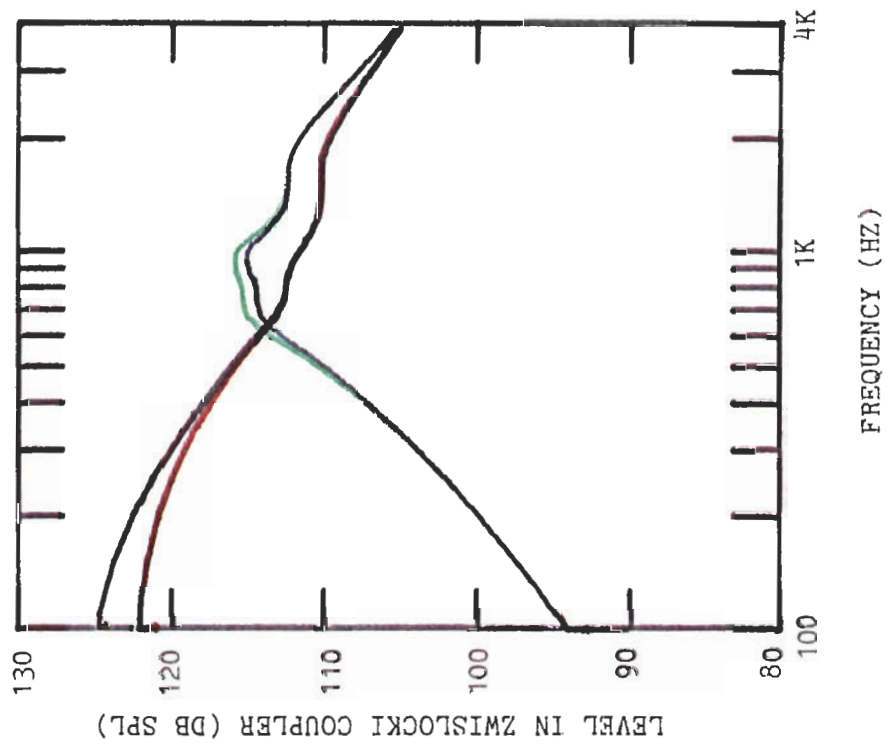

Fig.7: Calculated effects of 3 mm  $\emptyset$  vent, tight acoustic leak and 3 mm  $\emptyset$  vent plus tight acoustic leak on Zwislöcki coupler response.

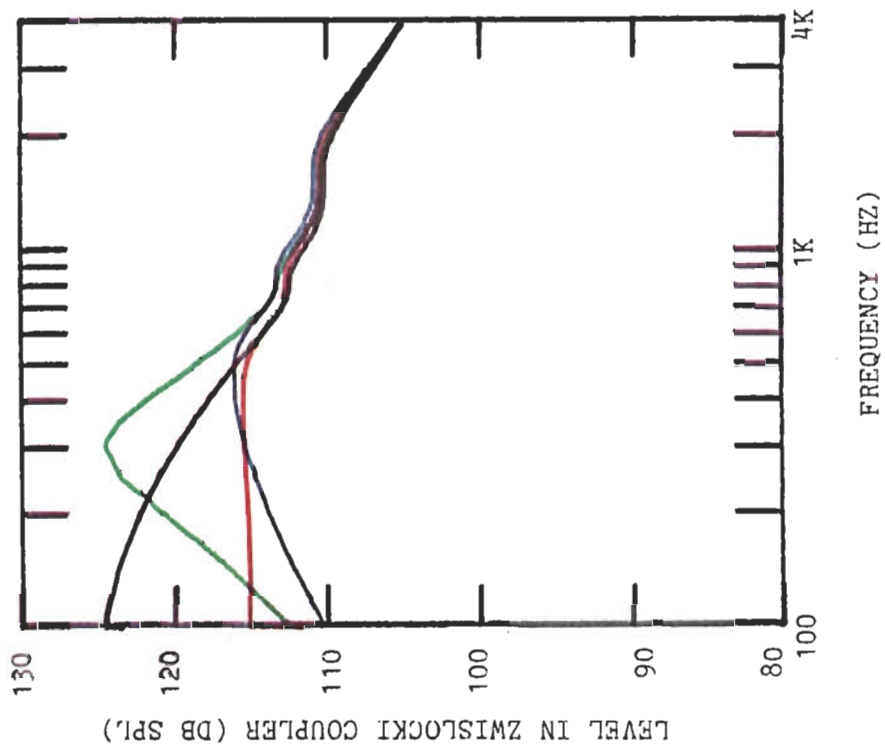

Fig. 8: Calculated effects of 1 mm  $\varnothing$  vent, loose acoustic leak and 1 mm  $\varnothing$  vent plus loose acoustic leak on Zwislocki coupler response.

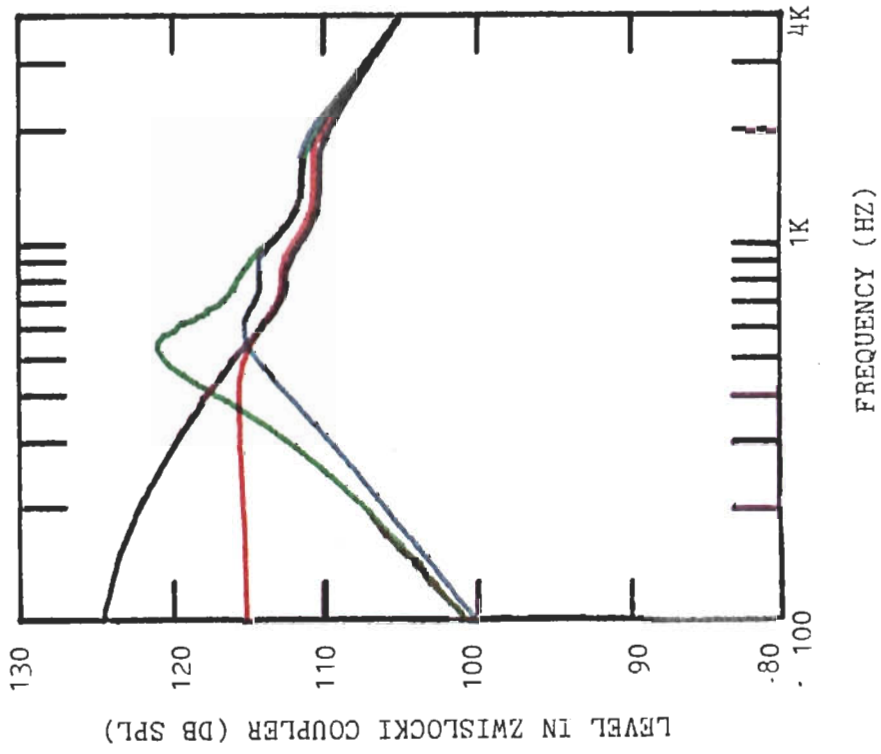

Fig.9: Calculated effects of 2 mm  $\emptyset$  vent, loose acoustic leak and 2 mm  $\emptyset$  vent plus loose acoustic leak on Zwislowski coupler response.



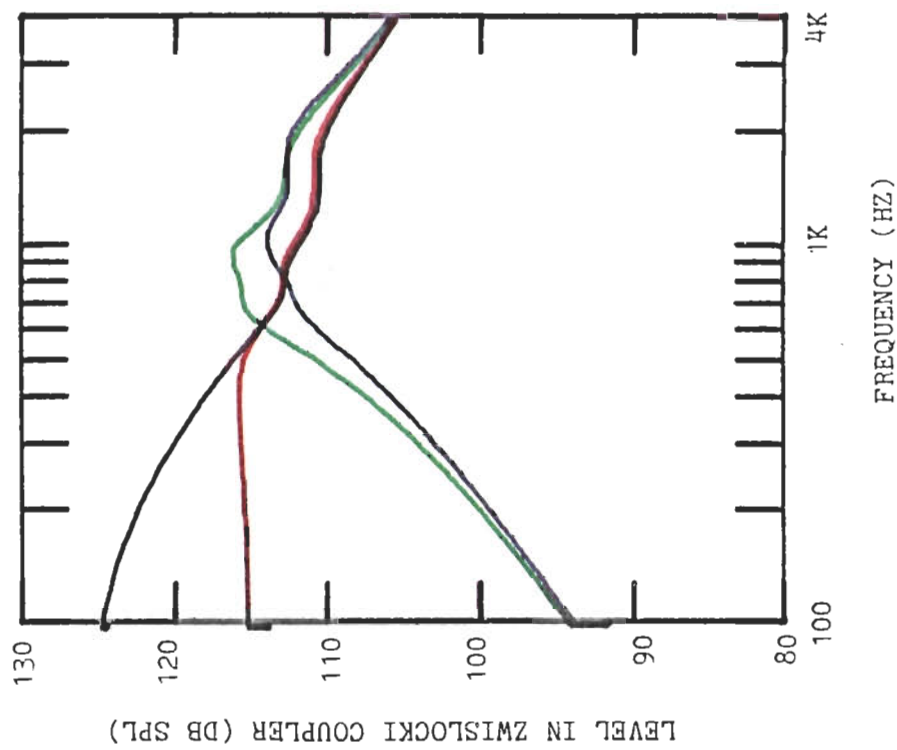

Fig.10: Calculated effects of 3 mm  $\emptyset$  vent, loose acoustic leak and 3mm  $\emptyset$  vent plus loose acoustic leak on Zwislowski coupler response.

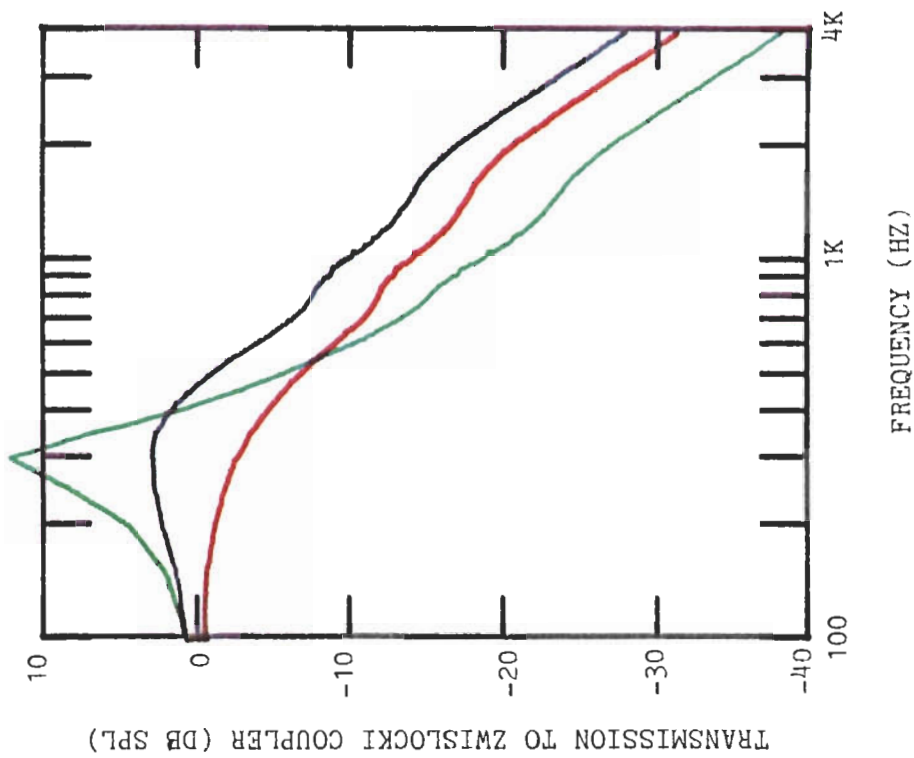

Fig. 11: Calculated transmission of sound to Zwislocki coupler through 1 mm  $\emptyset$  vent, normal acoustic leak and 1 mm  $\emptyset$  vent plus normal acoustic leak.

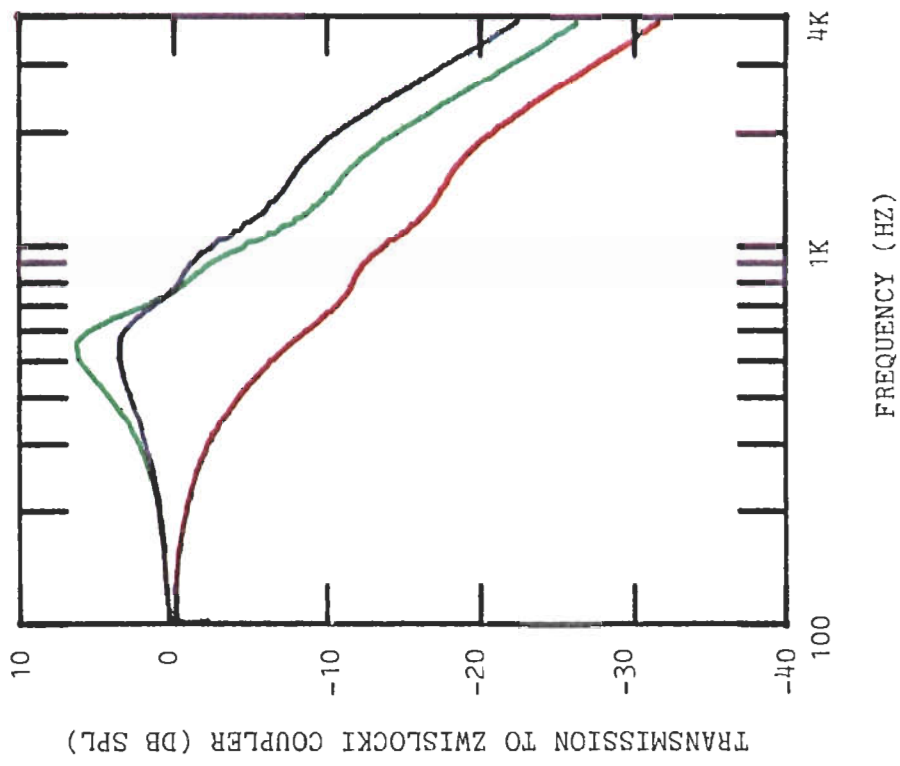

Fig.12: Calculated transmission of sound to Zwislocki coupler through 2 mm  $\emptyset$  vent, normal acoustic leak and 2 mm  $\emptyset$  vent plus normal acoustic leak.

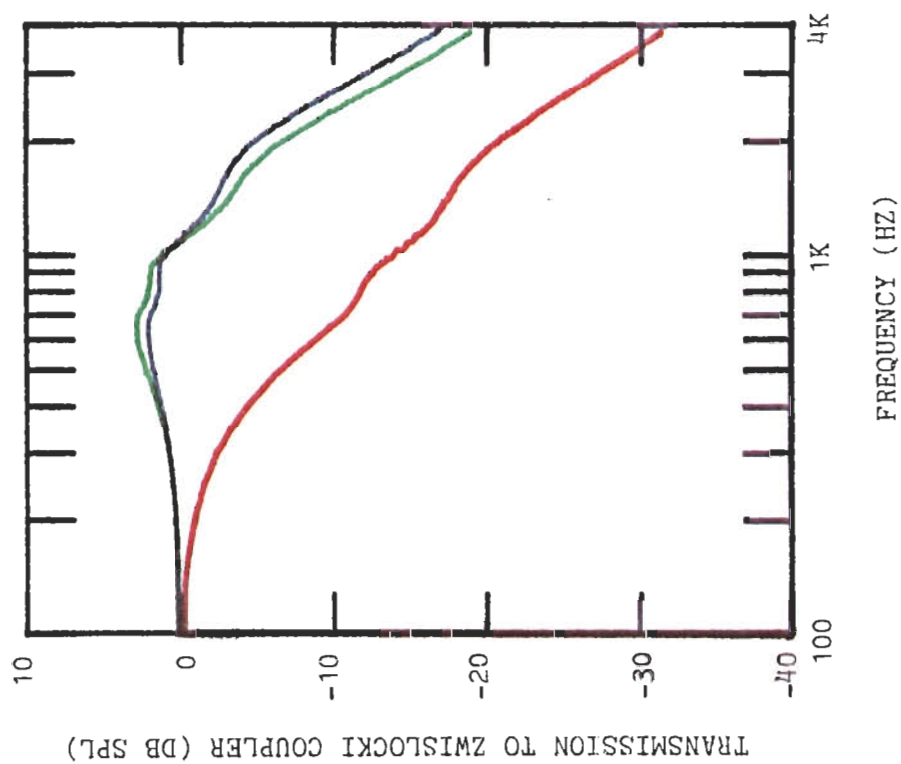

Fig. 13: Calculated transmission of sound to Zwislocki coupler through 3 mm  $\emptyset$  vent, normal acoustic leak and 3 mm  $\emptyset$  vent plus normal acoustic leak.

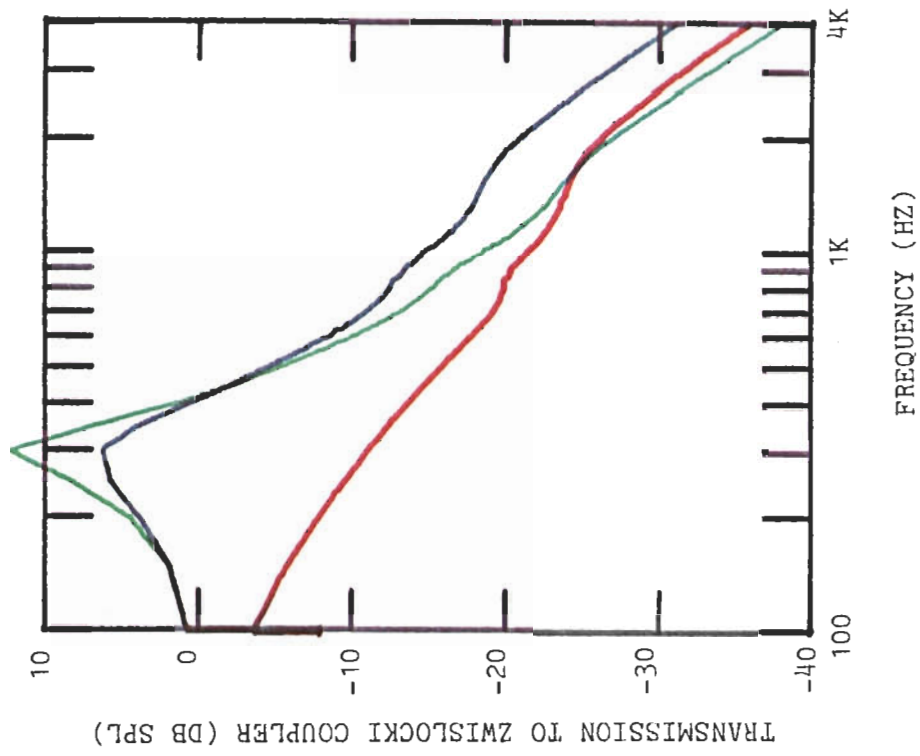

Fig. 14: Calculated transmission of sound to Zwislocki coupler through 1 mm  $\emptyset$  vent, tight acoustic leak and 1 mm  $\emptyset$  vent plus tight acoustic leak.

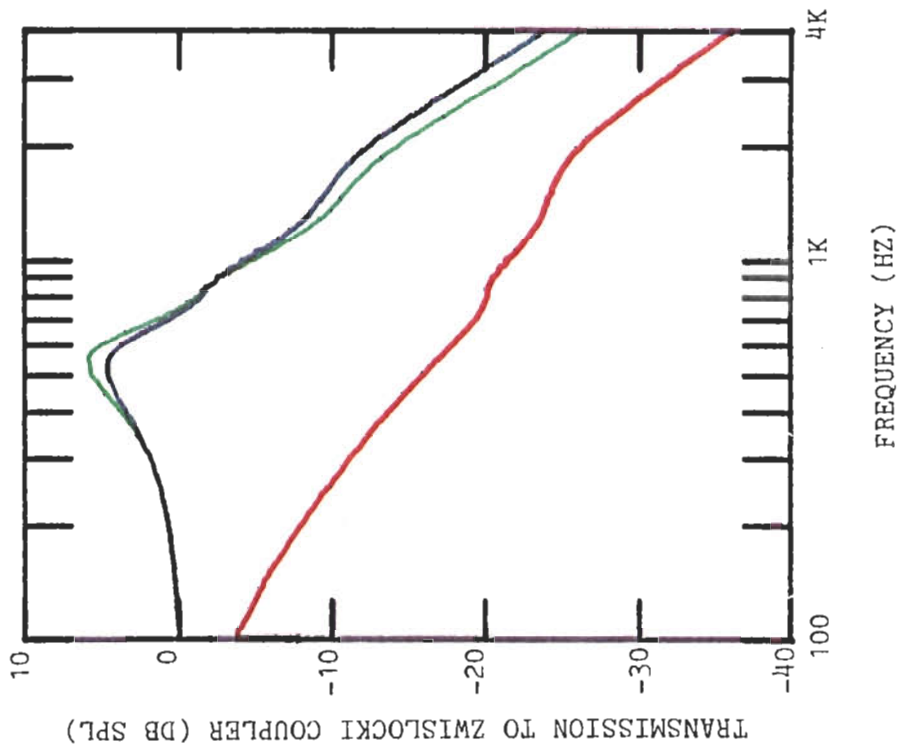
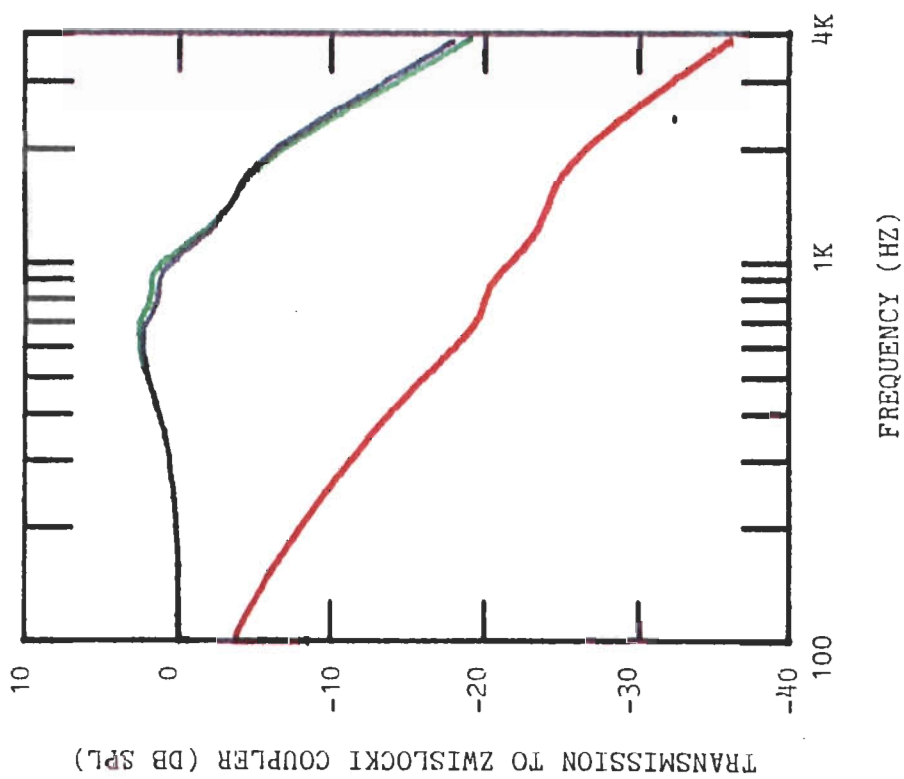

Fig.15: Calculated transmission of sound to Zwislocki coupler through 2 mm  $\emptyset$  vent, tight acoustic leak and 2 mm  $\emptyset$  vent plus tight acoustic leak.



**Fig. 16:** Calculated transmission of sound to Zwisllocki coupler through 3 mm  $\emptyset$  vent, tight acoustic leak and 3 mm  $\emptyset$  vent plus tight acoustic leak.

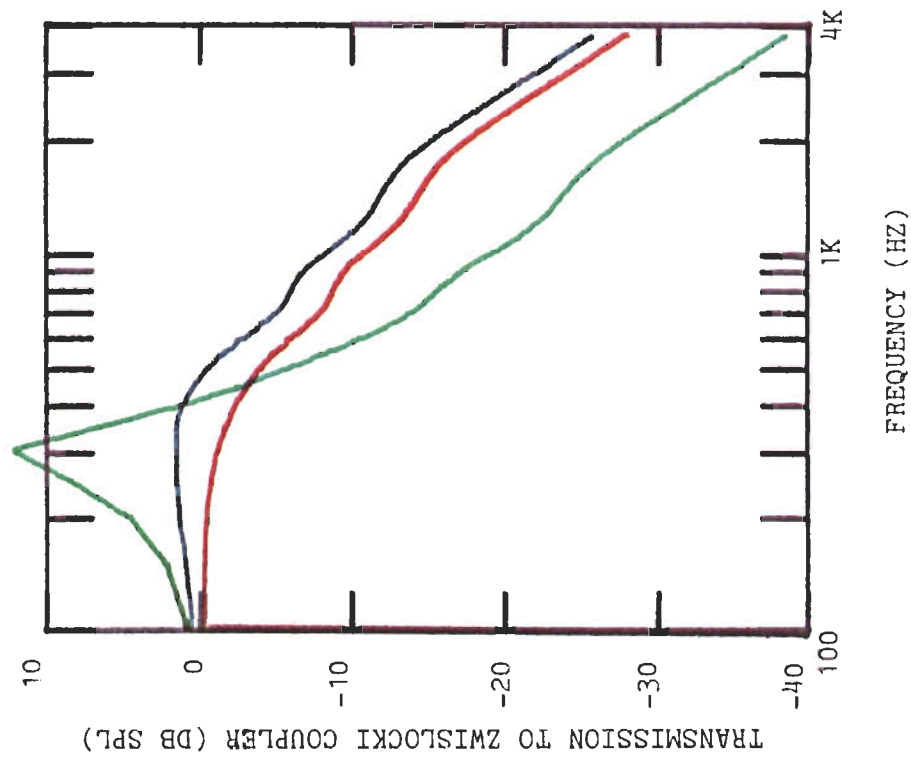

Fig. 17: Calculated transmission of sound to Zwislocki coupler through 1 mm  $\emptyset$  vent, loose acoustic leak and 1 mm  $\emptyset$  vent plus loose acoustic leak.



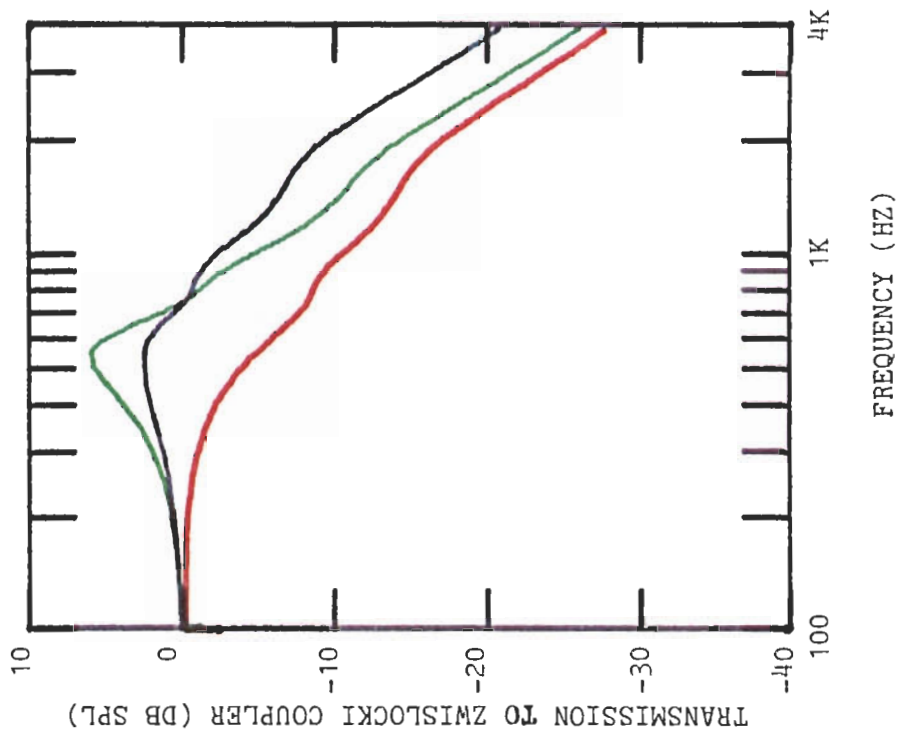

Fig. 18: Calculated transmission of sound to Zwislocki coupler through 2 mm  $\emptyset$  vent, loose acoustic leak and 2 mm  $\emptyset$  vent plus loose acoustic leak.

NATIONAL ACOUSTIC  
 LABS. C.O. LIBRARY  
 ALRIN 0-4215  
 AN NA - copy A  
 DATE 81.11.12

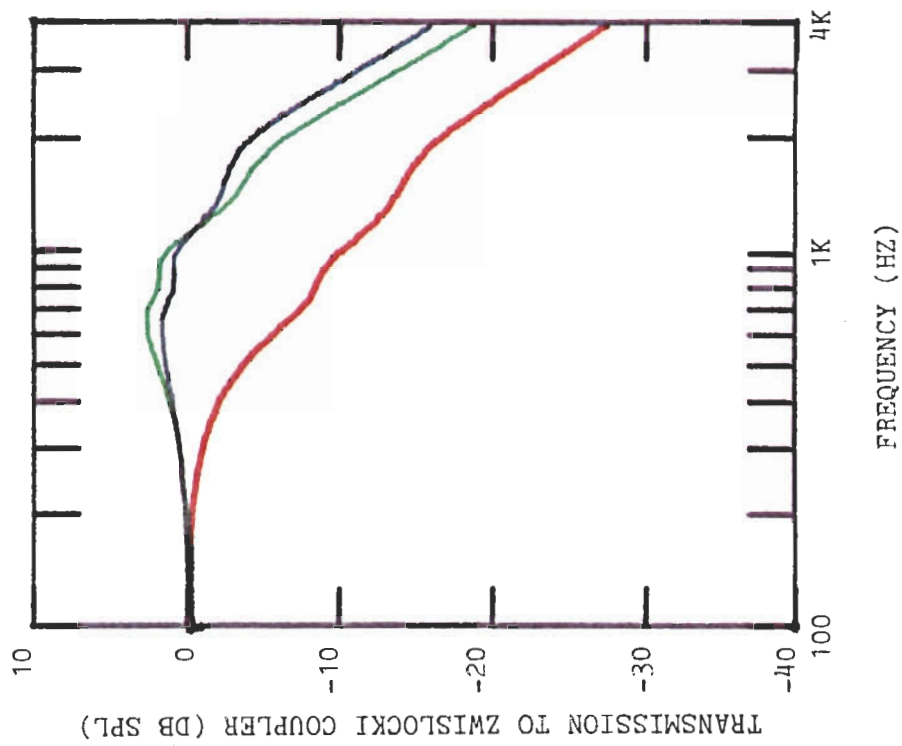

Fig. 19: Calculated transmission of sound to Zwislocki coupler through 3 mm  $\emptyset$  vent, loose acoustic leak and 3 mm  $\emptyset$  vent plus loose acoustic leak.